



1. Introduction:

- (1) Spring Operated Impact Hammer is strictly designed according to IEC60068-2-75 standard.
- (2) Spring Operated Impact Hammer is used to check the durability of enclosure for electrical appliance of other electronic product. The Impact Hammer simulates the mechanical impact to test household and similar electrical appliance shell, lever, handle, knobs, light and other shell to withstand mechanical shocks.

2. Application:

Pull the knob slowly out of the device until it locks in place. If moved too fast, the clamp may skip its arrester and will lock at its way back when the pulling-force declines. Hold the device horizontally at its housing tube and press the (black) release cone to the specimen's plane of impact. The strike is automatically released when the release force threshold is reached.

Technical parameters:

Length: 211mm
Weight: 1250g
Diameter: 50 mm
Hammer Weight: 60g
Hammer radius: 10mm

Shock components: including hit ball and hammer handles, weighs 250g, the hammer is made from white polyethylene imines first.

The impact of the release of force: less than 10N



Types:

Impact Energy	Error
0.35J	$\pm 0.03J$

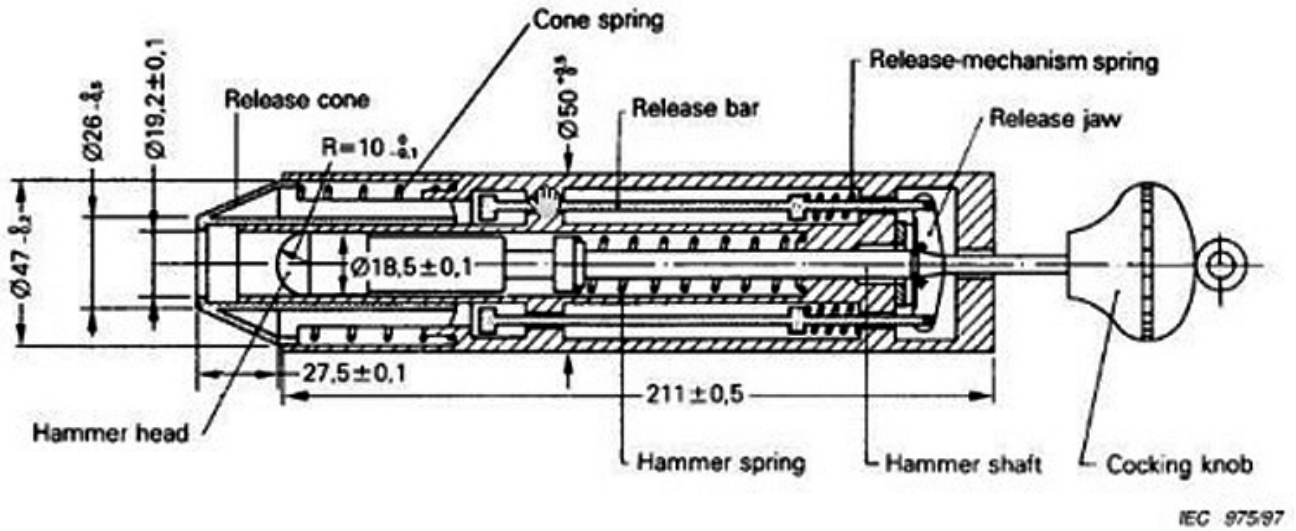

Figure E.1 – Spring hammer test apparatus